

E

STÜBBE

E-CLASS

STÜBBE E-CLASS PUMP

CHEMICAL CENTRIFUGAL PLASTIC PUMP
WITH MECHANICAL SEAL IN MONOBLOC DESIGN BE

FEATURES

- capacity up to 235 m³/h (1500 rpm)
- delivery head up to 68 m (3000 rpm)
- driving power up to 30 kW
- solids load up to max. 5%
- viscosity up to max. 100 mm²/s
- operating temperature:
 - PP up to max. 80 °C
 - PVDF up to max. 100 °C



E

STÜBBE E-CLASS

Chemical centrifugal pump BE

FEATURES

- STÜBBE E-CLASS: entry-level model in the STÜBBE pump family
- horizontal, single-stage centrifugal chemical plastic pump with mechanical seal in monobloc design (not self-priming)
- efficient hydraulics due to up-to-date calculation programs
- best possible price/performance ratio for elementary pumping tasks
- self-developed, innovative mechanical seal module kit (static pressure up to 6 bar)
- replaceable pump casing parts are made of solid plastic
- nozzles sealed with flat gaskets
- nozzle connection dimensions according to DIN EN ISO 2858 (optional: for discharge nozzle nominal width 32 threaded neck acc. to DIN 8063)
- impeller mounting independent of direction of rotation with sealed plastic cap
- slotted pump shaft mounted to the shaft journal of the motor for clamping by means of clamping screws
- easy disassembly and assembly
- reduction of parts due to modular system
- drain connection (standard)

USE

- pumping of neutral, aggressive, groundwater hazardous, toxic acids, alkalis or mixtures of solutions (Depending on the design of the mechanical seal, also suitable for crystallizing media and media with low solids content).
- This pump series is designed for indoor or protected installation only.
- Do not use pump for flammable or explosive media.

CUSTOMIZED HYDRALIC SYSTEM

Closed impellers (G):

- for best possible efficiency
- for clean media

All designs are marked with the 3rd letter in the type designation.

PUMP VARIETY

- 10 different pump sizes with closed impellers (G) up to 235 m³/h (BE 32-125 to BE 100-200)

STÜBBE RESISTANCE LIST

www.stuebbe.com/pdf_resistance/300050.pdf

SAFETY

- no alignment of pump and motor necessary
- thick-walled, vacuum-resistant, corrosion- and diffusion-resistant plastic housing

LONG-LIVED AND STURDY

- sturdy universal shaft for any available mechanical seal type
- chambered O-rings
- standard screw connection made of 1.4301
- high-quality painting of the metal components with a 2K protective lacquer

ATEX-COMPLIANT

According to directive 2014/34/EU (ATEX):

- unit group II
- category 2G
- temperature class T3 or T4

MATERIAL VARIANTS

Two materials are available for different applications depending on chemical and thermal stress:

- PP-H (homopolymer polypropylene [P])
- PVDF (polyvinylidene fluoride [D])
- conductive variants on request

All designs are marked with the 4th letter in the type designation.

OPTIONS

- hydraulic test run report in accordance with DIN EN ISO 9906, Class 3B (only flow rate, delivery head, electric motor power)
- installation on metal base plate

E









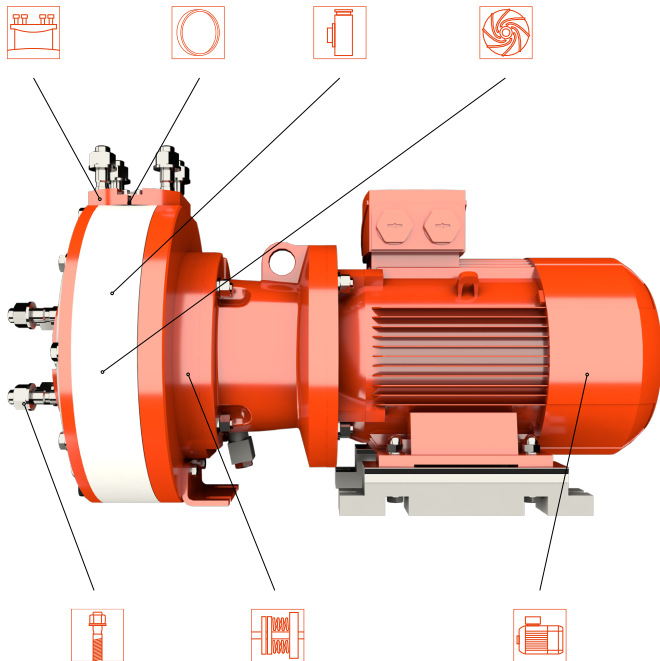





















STÜBBE E-CLASS
Chemical centrifugal
pump BE

- ✓ STANDARD
- OPTIONAL
- NOT AVAILABLE

¹ optionally with stand-
still flushing available
² only on request

VARIANTS



PUMP TYPE	BE SIZE I					BE SIZE II					
	bearing bracket size (LTG)	32-125	32-160	32-200	50-125	50-160	50-200	65-160	80-160	80-200	100-200
connections											
	DIN EN 1092-1	✓	✓	✓	✓	✓	✓	✓	✓	✓	✓
	ANSI	✓	✓	✓	✓	✓	✓	✓	✓	✓	✓
	threated neck DIN 8063	•	•	•	○	○	○	○	○	○	○
screws											
	1.4301	✓	✓	✓	✓	✓	✓	✓	✓	✓	✓
	1.4571	•	•	•	•	•	•	•	•	•	•
plastic (casing + impeller)											
	PP	✓	✓	✓	✓	✓	✓	✓	✓	✓	✓
	PVDF	✓	✓	✓	✓	✓	✓	✓	✓	✓	✓
	conductive	•	•	•	•	•	•	•	•	•	•
hydraulic/speed											
	half-open	○	○	○	○	○	○	○	○	○	○
	closed/1500 rpm	✓	✓	✓	✓	✓	✓	✓	✓	✓	✓
	closed/3000 rpm	✓	✓	✓	✓	✓	✓	✓	✓	○	○
o-rings											
	EPDM	✓	✓	✓	✓	✓	✓	✓	✓	✓	✓
	FKM	✓	✓	✓	✓	✓	✓	✓	✓	✓	✓
	FFKM	•	•	•	•	•	•	•	•	•	•
	FKM/FEP-covered	•	•	•	•	•	•	•	•	•	•
mechanical seal											
	singel-actingd (UV4) ¹	✓	✓	✓	✓	✓	✓	✓	✓	✓	✓
	singel-acting (UV4) with quench	✓	✓	✓	✓	✓	✓	✓	✓	✓	✓
	double-acting	○	○	○	○	○	○	○	○	○	○
motor											
	Lammers	✓	✓	✓	✓	✓	✓	✓	✓	✓	✓
	Siemens	•	•	•	•	•	•	•	•	•	•
	more on request	•	•	•	•	•	•	•	•	•	•
coating											
	RAL 2002	✓	✓	✓	✓	✓	✓	✓	✓	✓	✓
	special painting	•	•	•	•	•	•	•	•	•	•
accessories											
	stand quench container	✓	✓	✓	✓	✓	✓	✓	✓	✓	✓
	self-priming container	•	•	•	•	•	•	•	•	•	•
	base plate ²	•	•	•	•	•	•	•	•	•	•
	grounding	•	•	•	•	•	•	•	•	•	•
	assembly tool	•	•	•	•	•	•	•	•	•	•
	PTM pressure and temperature sensor	✓	✓	✓	✓	✓	✓	✓	✓	✓	✓
	further accessories on request	•	•	•	•	•	•	•	•	•	•

E

STÜBBE E-CLASS

Chemical centrifugal pump BE

MECHANICAL SEALS

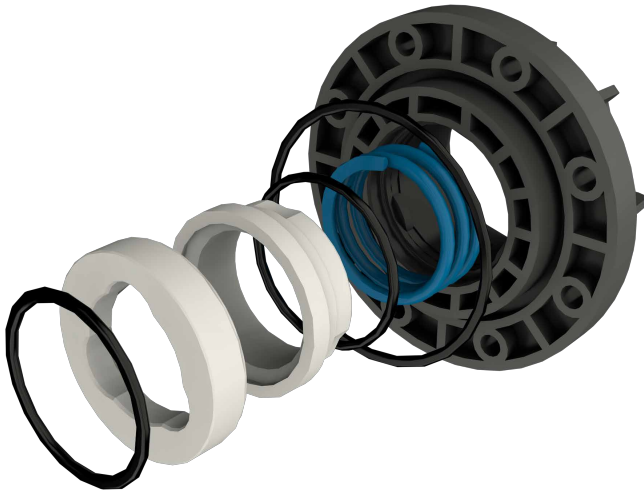

SINGLE-ACTING MECHANICAL SEAL TYPE STÜBBE UV4

- nearly universal chemical resistance
- robust spring-loaded mechanical seal in „FGD“-design
- up to 100 °C and up to 3 bar(g) inlet pressure
- up to 6 bar(g) static pressure
- counter ring made of SSiC/carbon
- sliding ring made of SSiC
- Halar-coated spring made of stainless steel
- sturdy seal casing made of fibre-reinforced plastic
- with sliding ring and counter ring, moments are transmitted via a robust plastic-compatible drive (breakaway torque in the case of adhesion and adhesion forces)
- depending on requirements, the following versions are available:
 - internal flushing (A)
 - internal flushing and quench (B)
 - standstill flushing (C)

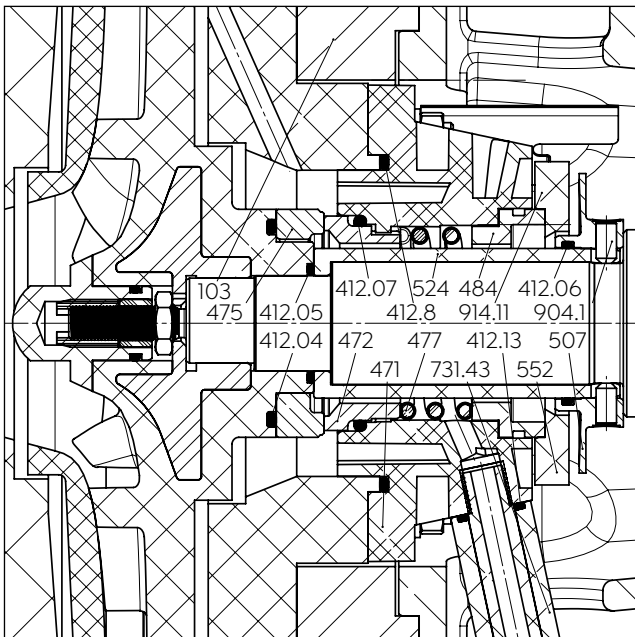

A) VERSION WITH INTERNAL FLUSHING – API PLAN 01 TYPE ES4N

- for uncritical applications
- flushing of the mechanical seal with pumped medium

E

STÜBBE E-CLASS

Chemical centrifugal pump BE

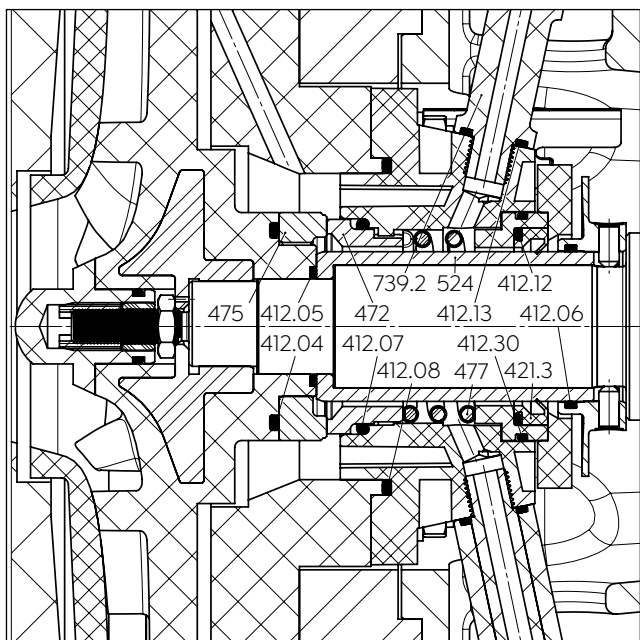

B) VERSION WITH INTERNAL FLUSHING AND QUENCHING – API PLAN 62 TYPE QS4N

- sealing of the seal casing (471) on the atmosphere side by means of a radial rotary shaft seal (421.3)
- the hollow space thus created is supplied with quench medium (e.g. deionized water):
 - quench medium is limited to 30 l / h at pressures between 0.8 and 8 bar by built-in flow limiter (ensure free discharge of quench medium, maximum pressure in quench chamber 0.5 bar [g])
 - prevents crystallization on the mechanical seal
 - protection against overheating of the mechanical seal in the event of negative pressure in the area of the rotary shaft seal
 - can also be used in the stand quench version (with quench container, quench liquid in the circuit, without flow limiter).

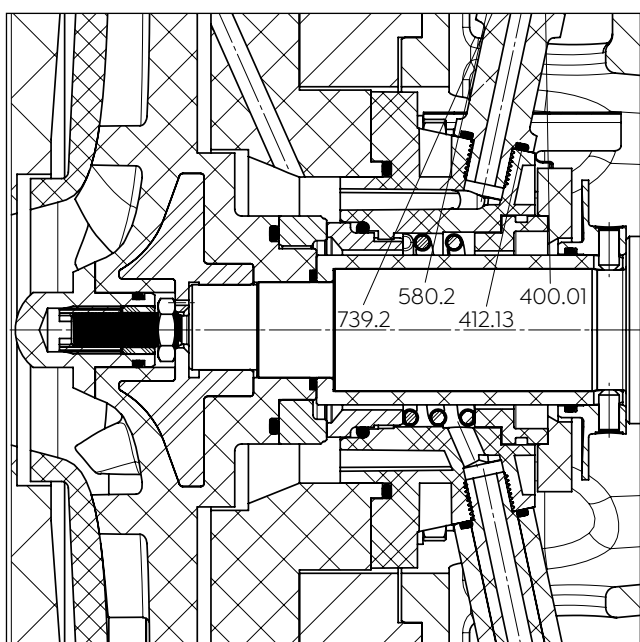

C) VERSION WITH STANDSTILL FLUSHING – API PLAN 32 TYPE ES4S

- If pumped media is contaminated with solids the standstill flushing can be used to flush away solid deposits or adhesions in the pump interior.
- flushing medium gets into the pumped medium, therefore only applicable if a permanent introduction of flushing media is not allowed due to the process, e.g. in evaporation processes or applications with sulfuric acid.
- flushing of the mechanical seal (max. 3 bar) with clean flushing medium (e.g. water) immediately before or at the same time as the pump is switched off (approx. 50–100 l for approx. 1–2 min flushing time)
- prevents sedimentation, sticking and/or crystallization in the pump interior in the area of the mechanical seal during standstill

E

STÜBBE E-CLASS

Chemical centrifugal pump BE

SECTIONAL VIEW

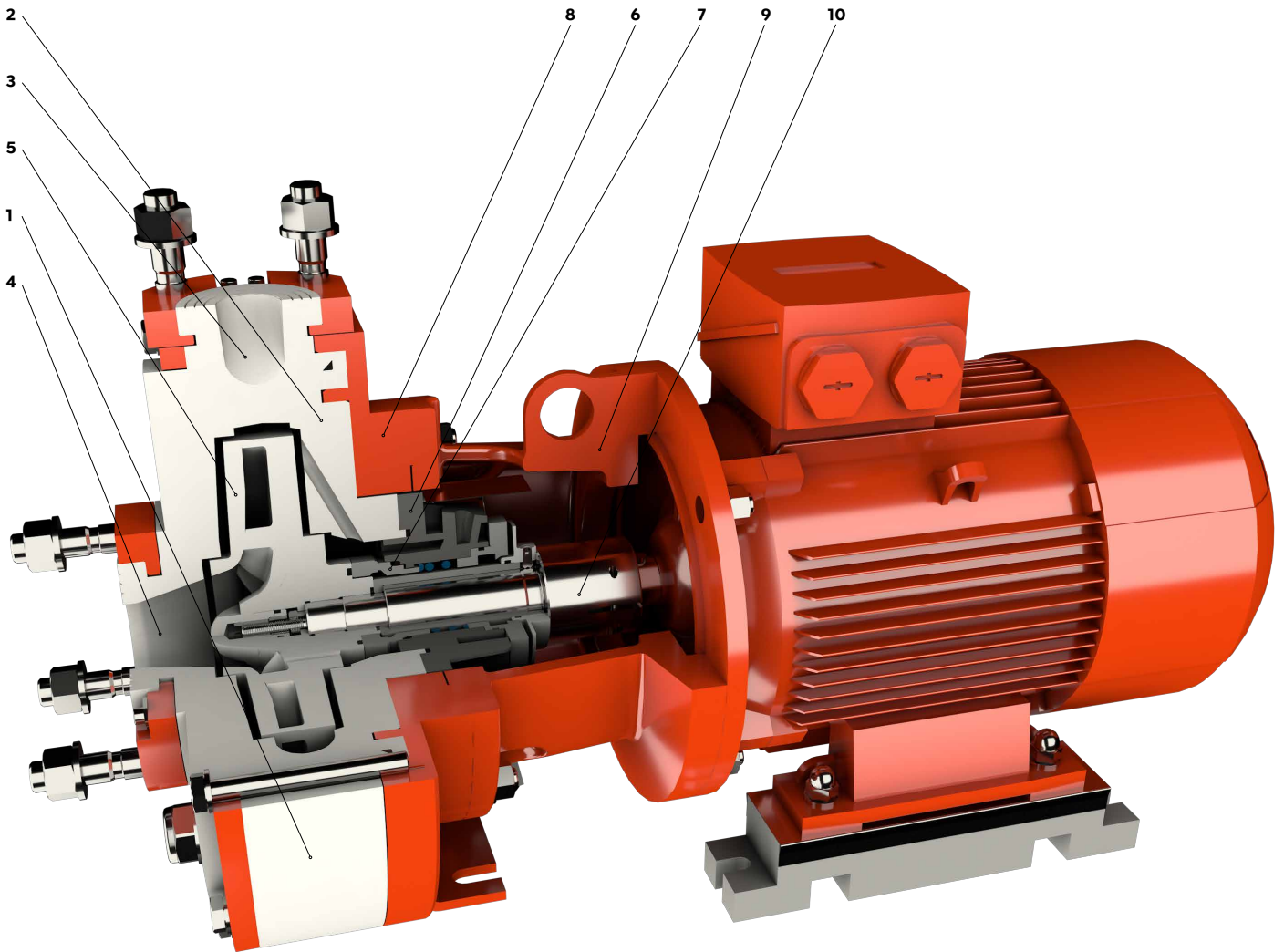

POSITION	DESCRIPTION
1	volute casing
2	casing cover
3	discharge nozzle
4	suction nozzle
5	impeller
6	seal casing
7	mechanical seal

POSITION	DESCRIPTION
8	ring casing
9	drive lantern
10	pump shaft
11	motor
12	support foot
13	leakage connection
14	motor mounting plate

E

STÜBBE E-CLASS

Chemical centrifugal
pump BE

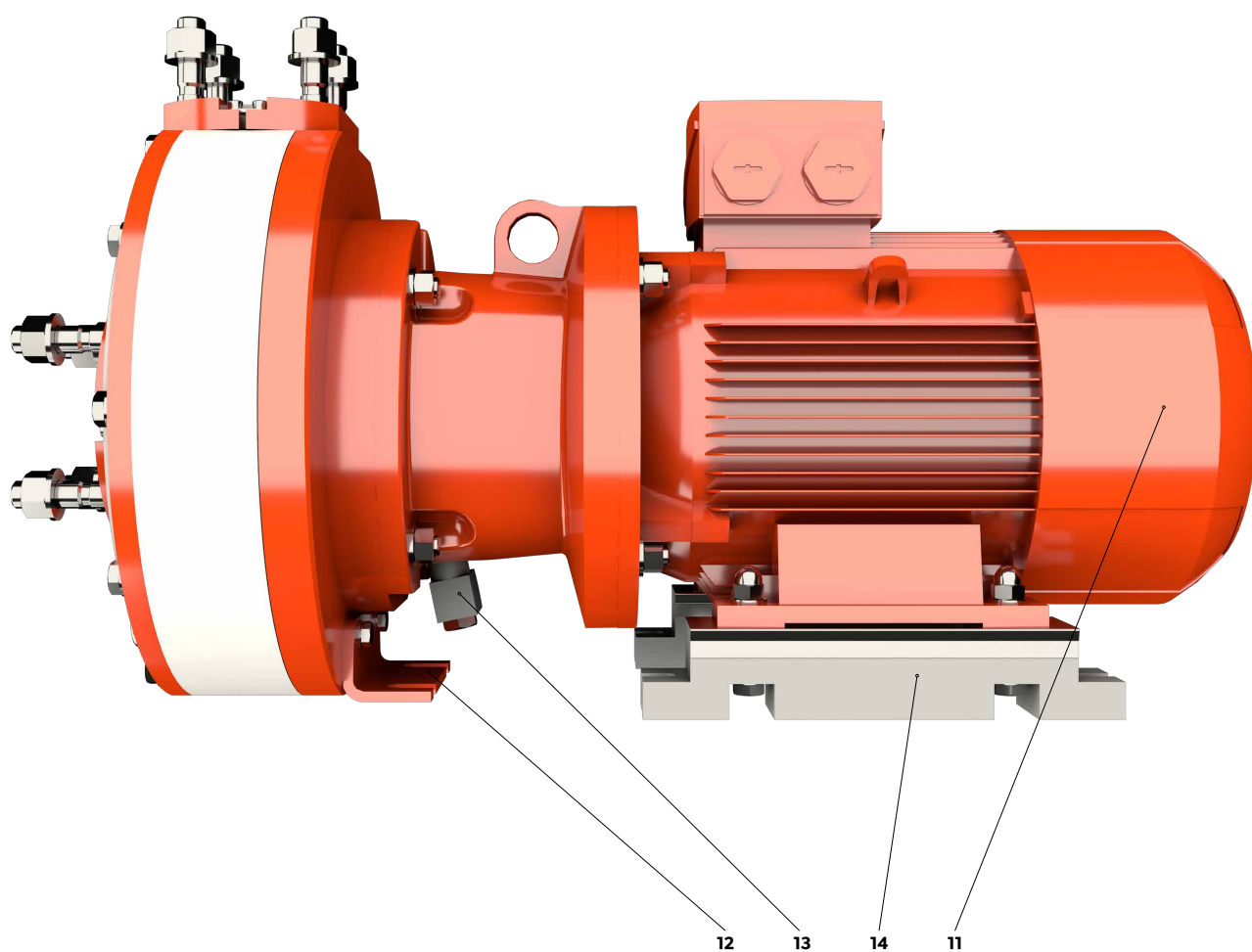

E

STÜBBE E-CLASS

Chemical centrifugal pump BE

SECTIONAL VIEW

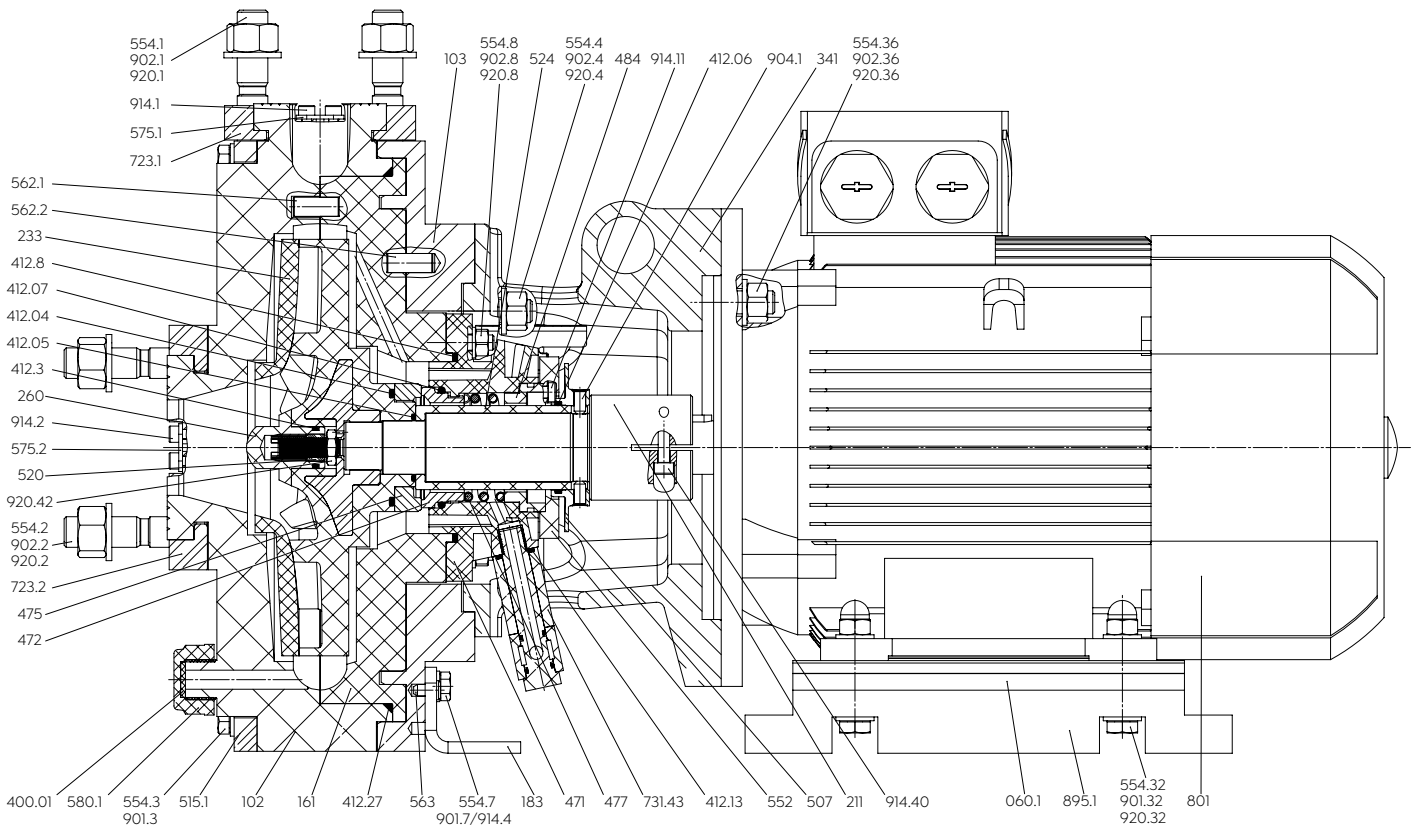
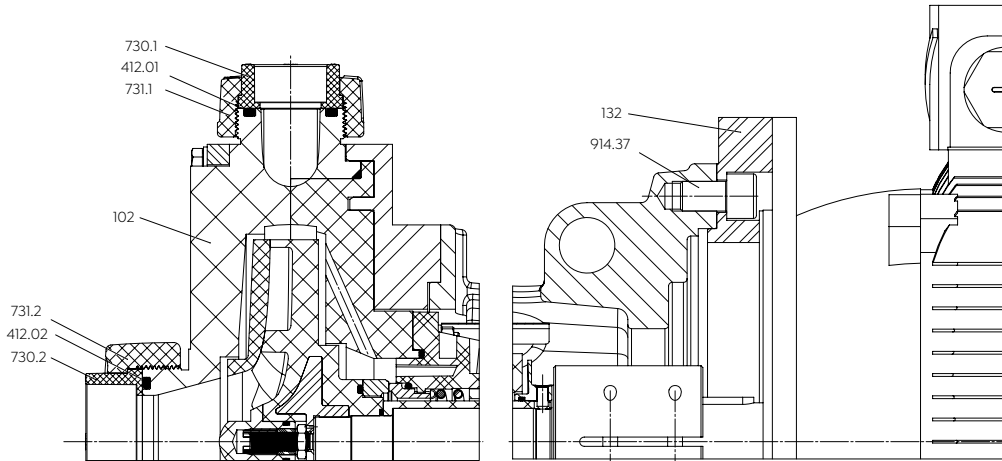

E

STÜBBE E-CLASS

Chemical centrifugal
pump BE

POSITION	DESCRIPTION
050.1	flow regulator
060.1	electric charges deflection sheet
102	volute casing
103	ring casing
116	casing insert
132	motorflange adapter
161	casing cover
183	support foot
211	pump shaft
233	impeller
260	impeller cap
341	drive lantern
400.01	gasket
412.01	o-ring
421.3	radial rotary shaft seal
471	seal casing
472	sliding ring
474	thrust ring
475	counter ring
477	spring
484	spring seat
507	splash ring
510	clamping ring

POSITION	DESCRIPTION
515.1	tension ring
520	sleeve
524	shaft sleeve
552	tension disc
554.1	washer
562.1	parallel pin
563	bolt
566.33	threaded bolt
575.1	fastening clip
580.1	cap
723.1	flange
730.1	union spigot end for fusion welding
731.1	union nut
731.43	screw fitting
739.1	hose nozzle
801	flange motor
895.1	mounting plate
901.3	hex screw
902.1	stud bolt
904.1	thread pin
914.1	cylinder screw
916.4	plug
920.1	hex nut

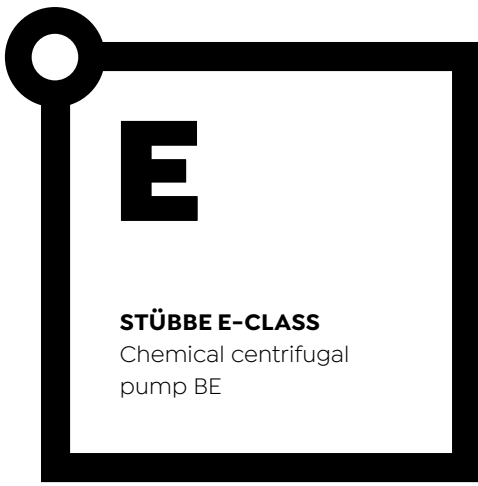

- BEARING BRACKET SIZE I
- BEARING BRACKET SIZE II

CHARACTERISTIC CURVES

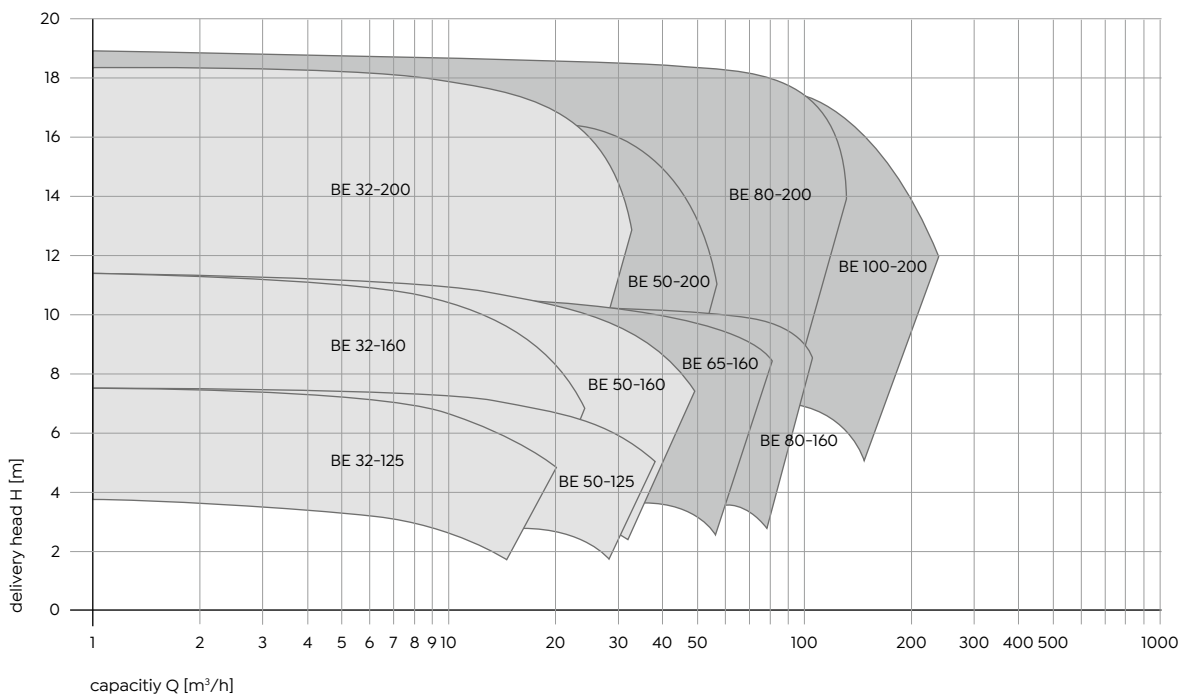
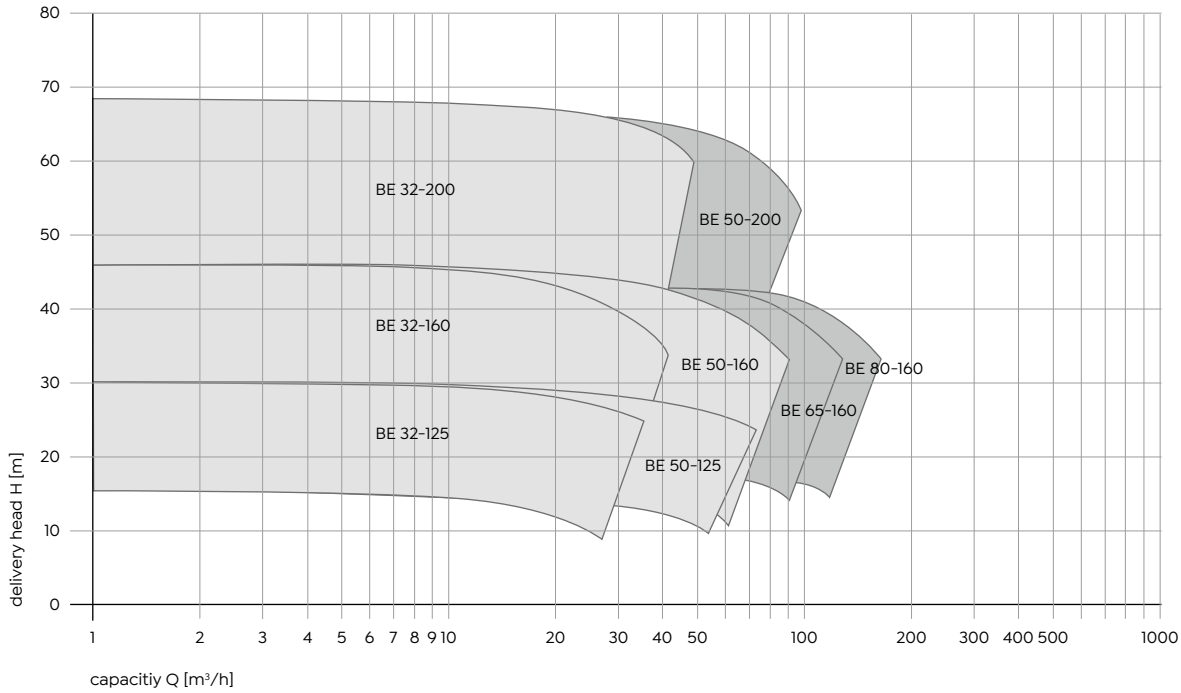

E

STÜBBE E-CLASS

Chemical centrifugal pump BE

PUMP DIMENSIONS

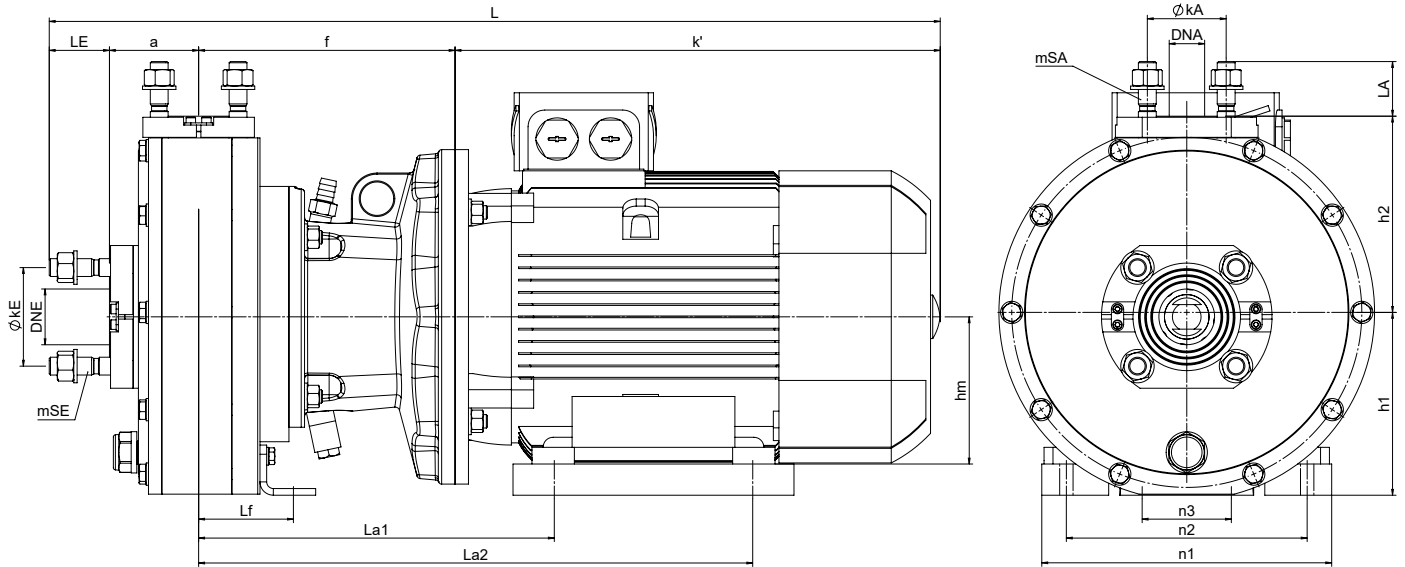

PUMP SIZE	SIZE PUMP CONNECTION				FLANGE DIN					FLANGE ANSI					THREADED NECK					
	DNE	DNA	a	h2	øKE	mSE	LE	øKA	mSA	LA	øKE	mSE	LE	øKA	mSA	LA	øpipe E	LE	øpipe A	LA
BE 32-125	50	32	80	140	125	4 X M16	54	100	4 X M16	49	120,6	4 X M16	54	88,9	4 X M12	44	63	30,5	40	23,5
BE 32-160	50	32	80	160	125	4 X M16	54	50	4 X M16	49	120,6	4 X M16	54	88,9	4 X M12	44	63	30,5	40	23,5
BE 32-200	50	32	80	180	125	4 X M16	54	50	4 X M16	49	120,6	4 X M16	54	88,9	4 X M12	44	63	30,5	40	23,5
BE 50-125	80	50	100	160	160	8 X M16	59	125	4 X M16	54	152,4	4 X M16	59	120,6	4 X M16	54	-	-	-	-
BE 50-160	80	50	100	180	160	8 X M16	59	125	4 X M16	54	152,4	4 X M16	59	120,6	4 X M16	54	-	-	-	-
BE 50-200	80	50	100	200	160	8 X M16	59	125	4 X M16	54	152,4	4 X M16	59	120,6	4 X M16	54	-	-	-	-
BE 65-160	100	65	100	210	180	8 X M16	59	145	4 X M16	54	190,5	8 X M16	59	139,7	4 X M16	54	-	-	-	-
BE 80-160	125	80	110	225	210	8 X M16	57,5	160	8 X M16	54	215,9	8 X M20	57,5	154,2	4 X M16	54	-	-	-	-
BE 80-200	125	80	110	250	210	8 X M16	57,5	160	8 X M16	54	215,9	8 X M20	57,5	154,2	4 X M16	54	-	-	-	-
BE 100-200	125	100	110	280	210	8 X M16	57,5	180	8 X M16	54	215,9	8 X M20	57,5	190,5	8 X M16	54	-	-	-	-

E

STÜBBE E-CLASS

Chemical centrifugal
pump BE

UNIT DIMENSIONS

pump size	motor size	h1	f	Lf	la1	La2	n1	n2	n3	k'	L (flange)	L (threaded neck)
BE 32-125	90S/L	132	200	80	222,5	414,5	175	135	70	297/337	631/671	608/648
BE 32-125	100L	132	210	80	273	413	204	160	70	370,5	714,5	691
BE 32-125	112M	132	210	80	280	420	230	190	70	354	698	674,5
BE 32-125	132S	160	230	80	319	497	260	216	70	435	799	775,5
BE 32-160	90S/L	132	200	80	222,5	414,5	175	135	70	297/337	631/671	608/648
BE 32-160	100L	132	210	80	273	413	204	160	70	370,5	714,5	691
BE 32-160	112M	132	210	80	280	420	230	190	70	354	698	674,5
BE 32-160	132S	160	230	80	319	497	260	216	70	435	799	775,5
BE 32-160	160M	180	260	80	368	622	310	254	70	494	888	864,5
BE 32-200	90S/L	160	200	85	222,5	414,5	175	135	80	297/337	631/671	608/648
BE 32-200	100L	160	210	85	228	458	204	154	80	370,5	714,5	691
BE 32-200	112M	160	210	85	235	465	230	180	80	354	698	674,5
BE 32-200	132S	160	230	85	319	497	260	216	80	435	799	775,5
BE 32-200	160M/L	180	260	85	368	622	310	254	80	494/554	888/948	865/925
BE 32-200	180M	180	260	85	381	622	339	279	80	588	982	958,5
BE 50-125	90S/L	132	200	92	222,5	414,5	175	135	70	297/337	656/696	-
BE 50-125	100L	132	210	92	273	413	204	160	70	370,5	739,5	-
BE 50-125	112M	132	210	92	280	420	230	190	70	354	723	-
BE 50-125	132S	160	230	92	319	497	260	216	70	435	824	-
BE 50-125	160M	180	260	92	368	622	310	254	70	494	913	-
BE 50-160	90S/L	160	200	100	222,5	414,5	175	135	80	297/337	656/696	-
BE 50-160	100L	160	210	100	228	458	204	154	80	370,5	739,5	-
BE 50-160	112M	160	210	100	235	465	230	180	80	354	723	-
BE 50-160	132S	160	230	100	319	497	260	216	80	435	824	-
BE 50-160	160M/L	180	260	100	368	622	310	254	80	494/554	913/973	-
BE 50-160	180M	180	260	100	381	622	339	279	80	588	1007	-
BE 50-200	90S/L	160	200	115	222,5	414,5	175	135	80	297/ 337	656/696	-
BE 50-200	100L	160	210	115	228	458	204	154	80	370,5	739,5	-
BE 50-200	112M	160	210	115	235	465	230	180	80	354	723	-
BE 50-200	132S	160	230	115	319	497	260	216	80	435	824	-
BE 50-200	160M/L	180	260	115	368	622	310	254	80	494/554	913/973	-
BE 50-200	180M/L	180	260	115	381	622/660	339	279	80	588	1007	-
BE 65-160	90S/L	160	200	115	222,5	414,5	175	135	80	297/337	656/696	-
BE 65-160	100L	160	210	115	228	458	204	154	80	370,5	739,5	-
BE 65-160	112M	160	210	115	235	465	230	180	80	354	723	-
BE 65-160	132S	160	230	115	319	497	260	216	80	435	824	-
BE 65-160	160M/L	180	260	115	368	622	310	254	80	494/554	913/973	-
BE 65-160	180M/L	180	260	115	381	622/660	339	279	80	588	1007	-
BE 80-160	90L	180	200	120	222,5	414,5	175	135	80	337	704,5	-
BE 80-160	100L	180	210	120	228	458	204	154	80	370,5	748	-
BE 80-160	112M	180	210	120	235	465	230	180	80	354	731,5	-
BE 80-160	132S/M	180	230	120	269,5	546,5	260	200	80	435	832,5	-
BE 80-160	160M/L	180	260	120	368	622	310	254	80	494/554	921,5/981,5	-
BE 80-160	180M/L	180	260	120	381	622/660	339	279	80	588	1015,5	-
BE 80-200	100L	180	210	120	228	458	204	154	80	370,5	748	-
BE 80-200	112M	180	210	120	235	465	230	180	80	354	731,5	-
BE 80-200	132S/M	180	230	120	269,5	546,5	260	200	80	435	832,5	-
BE 80-200	160M/L	180	260	120	368	622	310	254	80	494/554	921,5/981,5	-
BE 80-200	180M/L	180	260	120	381	622/660	339	279	80	588	1015,5	-
BE 100-200	112M	210	210	130	235	465	230	180	80	354	731,5	-
BE 100-200	132S/M	210	230	130	269,5	546,5	260	200	80	435	832,5	-
BE 100-200	160M/L	210	260	130	312,5	677,5	310	240	80	494/554	921,5/981,5	-
BE 100-200	180M/L	210	260	130	381	660	344	279	80	588	1015,5	-